

Data Sheet



Article number: 201146616

Description: E+G Stainless steel lock pin
GN 114.6-6-16

Measures

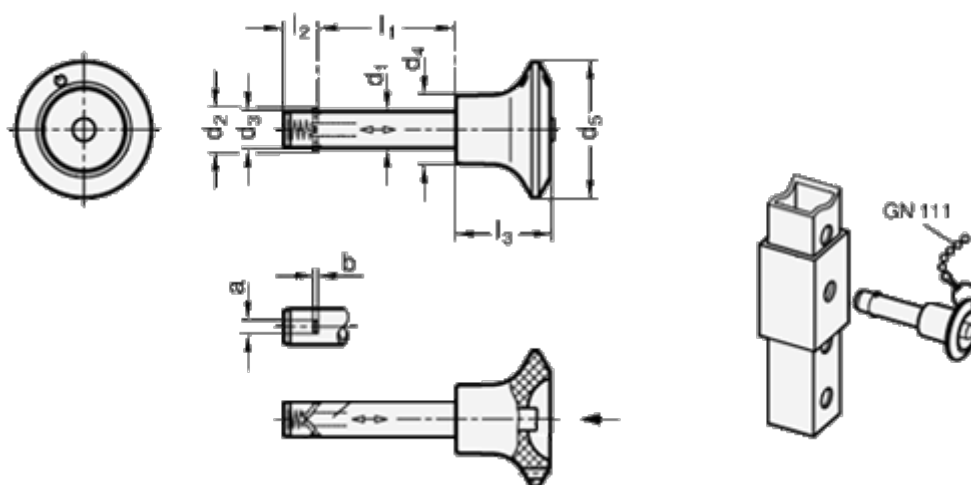

a = 2.3

d1 = 6

d2 = 7.5

d3 = 5.9

d4 = 12.0

d5 = 25

l1 = 16

l2 = 7.0

l3 = 20

Resilience (N) = 14